

V2X – AN IMPORTANT BUILDING BLOCK IN COOPERATIVE INTELLIGENT TRANSPORT SYSTEMS (C-ITS)

Authors

| | | |
|--------------------|--|------------------------|
| Thomas Adam | | TE Automotive Wireless |
| Swen Kopp | | TE Automotive Wireless |
| Steffen Lang | | TE Automotive Wireless |
| Andreas Winkelmann | | TE Automotive Wireless |

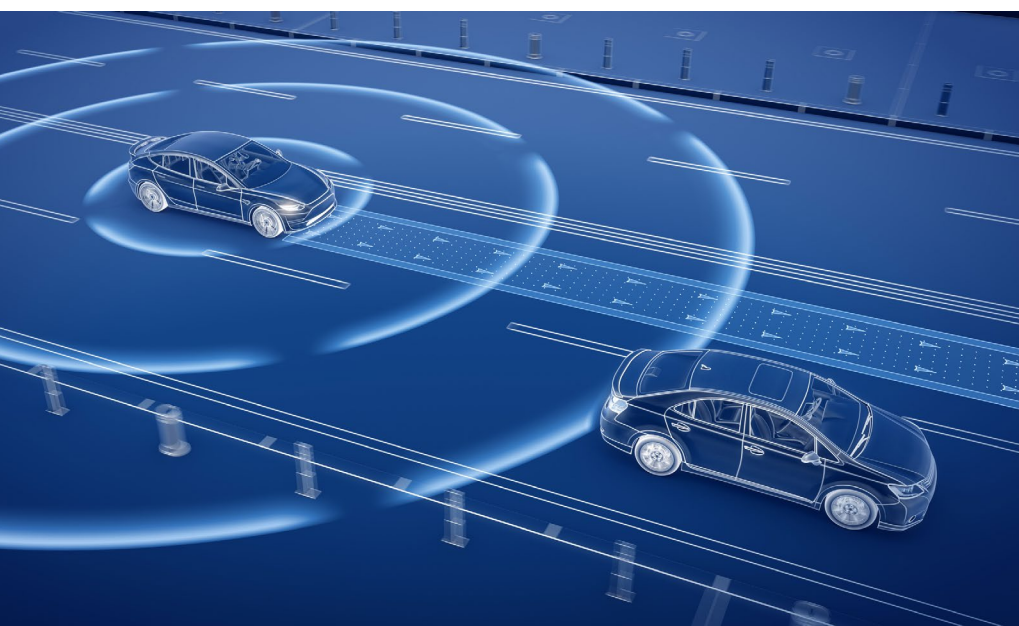

CONTENT

| | |
|--|-----------|
| 1. Overview V2X | 3 |
| 2. V2X standards and regulations. | 4 |
| 3. Vehicle architectures and V2X | 5 |
| 3.1. Complete V2X control unit | 5 |
| 3.2. Distributed V2X system | 6 |
| 3.3. V2X antenna architecture | 7 |
| 4. TE product overview V2X | 8 |
| 4.1. Antennas for cars | 8 |
| 4.2. Antennas for trucks. | 9 |
| 4.3. Antennas for two-wheelers | 9 |
| 4.4. Compensator | 9 |
| 4.5. V2X control units with vehicle network connection. | 10 |
| 5. Summary | 12 |
| References | 13 |

1. Overview V2X

Network connectivity is fast becoming the most important trend in the automotive industry. It all started with connecting the control units within the vehicle. Then smartphones were connected to the vehicle. Today, many cars are able to autonomously collect information from the web. The next logical step will be connecting cars with each other and the environment, using V2X technology.

V2X is short for “**vehicle to everything**”. The term describes a vehicle’s communication with surrounding or interacting road users and structures. For the discussion of the resulting connectivity applications derivatives like **V2V** (V = vehicle), **V2I** (I = infrastructure), **V2P** (P = pedestrian) and **V2N** (N = network) have been introduced.

The technology has also been called **C2X** (C = car), but this name is successively being replaced by the more general term “vehicle”.

Being able to automatically exchange real-time information between road users features attractive advantages in several ways:

1. Traffic safety

Reduction of the number of road accidents, especially fatal injuries

2. Environmental protection, cost and time savings

Efficient use of roads and other transport infrastructures for optimized traffic flows and reduced fuel consumption

V2X technology will also support autonomous driving. Autonomous vehicles require enormous amounts of data for their traffic decisions. Already today, ultra-modern ADAS systems in the vehicle detect the environment. In the future, however, additional information must be exchangeable between vehicles via V2X in order to make information available in so-called non-line of sight (NLOS) scenarios that cannot be detected by conventional sensors.

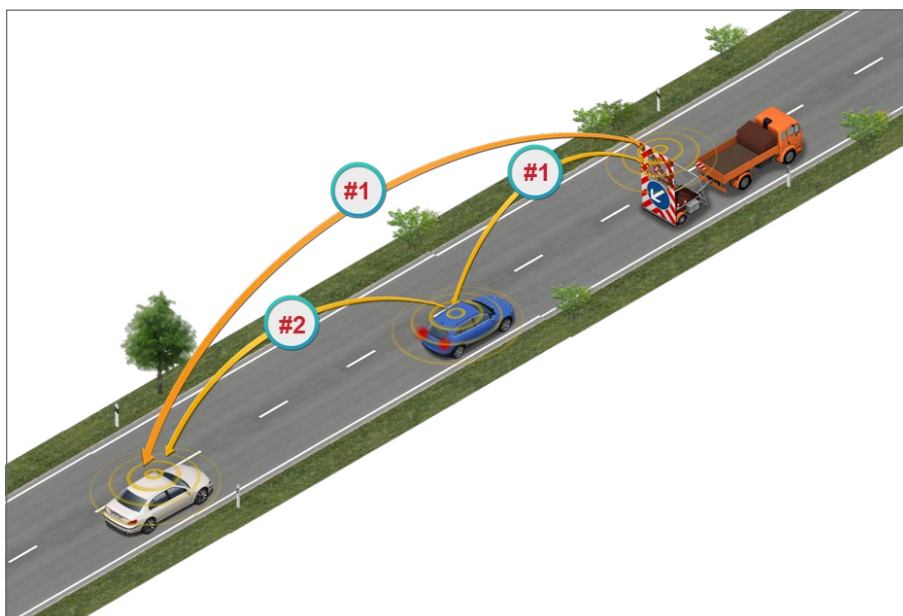

Fig. 1: V2X danger warning communication

For these scenarios, none-line-of-sight applications uses radio connections.

Applications where V2X will be instrumental are road works warnings (RWW), electronic emergency brake lights (EEBL), or emergency vehicle warnings (EVW). These are so-called Day-1 applications, as they will be realized in the first step of V2X rollout.

In all three applications, information can be exchanged between several vehicles or between vehicles and roadwork structures that cannot immediately be recognized by following vehicles resp. their drivers.

Such a scenario is shown in *figure 1*. A public roads trailer sends information to approaching vehicles (#1). As the road users hit the brake, following vehicles are automatically informed (#2). In this way, V2X contributes significantly to the detection of dangerous traffic situations and to early information of road users, thus enabling timely reactions.

The idea of vehicle-to-vehicle communication is not new. In fact, it has already been established in several applications: Fleet vehicles use mobile phone networks to warn each other of icy roads etc. The disadvantage of this communication method, however, is its high latency, caused by having to route via base stations. Accordingly, the basic idea of V2X is to enable direct real-time communication between the vehicles themselves.

The most important information in a V2X message is the exact position of the respective road users, their heading, and their velocity. This information is contained in every V2X message and enables predictions about future positions of all involved parties. Access to a GNSS system (GNSS = Global Navigation Satellite System, an umbrella term for GPS,

Galileo, GLONASS, Beidou) is therefore a vital prerequisite for any V2X system.

Appropriate processing of V2X information requires very high positioning precision, exact timing based on synchronous signals, heading, and reliable velocity input. All this relevant basic data are generated, among other things from the GNSS signals (see figure 2).

2. V2X standards and regulations

Currently, the market features two competing standards for supporting V2X communication: DSRC (dedicated short range communication) based on IEEE Wireless LAN technology 802.11, and C-V2X (cellular V2X) based on 3GPP mobile radio standard. Figure 3 illustrates the communication patterns in a cooperative intelligent traffic system (C-ITS), regardless of the selected standard.

It is not clear yet which V2X technology the automotive industry will eventually apply, with the global use of the technologies being concentrated at first on the U.S., Europe, Japan, and China.

In the U.S. the 5.9 GHz frequency spectrum has been reserved for DSRC. The U.S. Department of Transport (DOT) was already close to mandating the WLAN based standard. However, the DOT, which was considered a supporter of DSRC, left the decision for too long. Under the current administration, no V2X technology decision has yet been made. This continuing reticence has led many industry observers to assume that the U.S. is choosing the “let the market decide” option.

Europe has always been trending towards DSRC, as also intended by

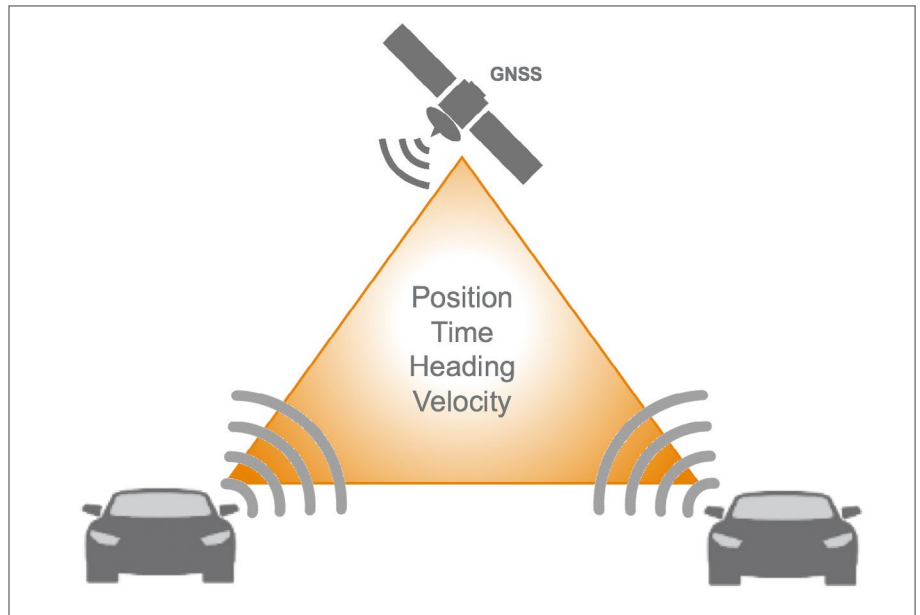

Fig. 2: V2X using GNSS as a basis

a European Commission’s delegated act. This act recommends the use of WLAN based (DSRC) devices for the communication of intelligent transport systems (ITS) in all of the EU. But following the veto of some member states, the European Commission decided to decline the proposed technical specifications for the definition of a WLAN based communication standard for inter-vehicle communication, thus postponing a final decision.

Japan has been using a modified version of the DSRC standard since 2015. The major difference in implementation compared to Europe or

the U.S. is the use of a different frequency range. While Europe and the U.S. use frequencies in the range of 5.9 GHz, Japan has opted for a frequency range of 760 MHz.

In China the situation is clear: Here C-V2X will be used. China faces major mobility challenges in the big cities, with many traffic jams and accidents. C-V2X is regarded as an efficient instrument for solving these problems, and the Chinese government wants to implement the standard rather sooner than later. With their existing guidelines and frequency allocations the Chinese administration is in a good position to

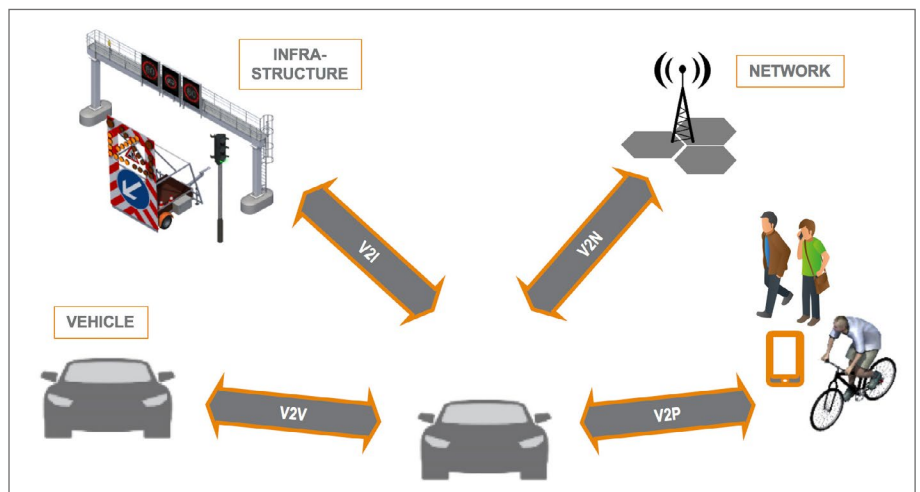

Fig. 3: Communication patterns in a C-ITS

launch the use of C-V2X as early as 2020/2021.

The table in *figure 4* features a comparison of essential information and technical parameters for the two competing standards for DSRC and C-V2X. C-V2X here refers to 3GPP releases 14 and 15.

With the introduction of 5G NR (new radio) C-V2X in 3GPP release 16, experts expect incompatibilities of the LTE and the 5G versions of C-V2X. How this will affect the implementation of market solutions remains to be seen. In the medium term, infrastructures consisting of roadside units and on-board units may have to support both standards.

3. Vehicle architectures and V2X

In the overall context of vehicle architectures, V2X usually is assigned to the sensors as a potential additional sensor unit. As described, V2X – as a sensor unit – currently is the only sensor with real-time non-line-of-sight capabilities.

Other sensors like cameras, lidar, or radar can only detect objects in their direct line of sight and are “blind” to everything outside their line of sight

Figure 5 illustrates a driver assistance system (ADAS) and the sensor technologies used. Generally, there are several approaches for imple-

menting a V2X system in a vehicle’s architecture.

3.1. Complete V2X control unit

An obvious approach is a fully independent V2X control unit, which integrates a complete V2X stack, positioning solution, security processing, and the vehicle data bus interfaces for the exchange of V2X and vehicle data. *Figure 6* illustrates the basic structure of such a control unit solution with its individual functional units.

The Day-1 applications described above are running on the control unit. Encoded messages received or sent via the V2X frontend are coded resp. decoded by a hardware security module (HSM).

| | IEEE 802.11p | C-V2X Rel-14/15 |
|--|--|---|
| Specification completed | Completed | Completed |
| Ready for roll out | ✓ | 2020/2021 |
| Support for low latency Direct communications | ✓ | ✓ |
| Operate without Network assistance | ✓ | ✓ |
| Operate in ITS 5.9GHz spectrum | ✓ | ✓ |
| Security and privacy | ✓ (as per IEEE WAVE and ETSI-IT security services) | ✓ (as per IEEE WAVE and ETSI-ITS security services) |
| Roadmap | 802.11bd: backward compatible and interoperable upgrade to 802.11p | C-V2X Rel-16: based on 5G NR. Operates in a different channel than Rel-14/15 |
| Base | Wireless LAN | LTE uplink |
| Synchronization | Asynchronous | Synchronous |
| Channel size | 10/20MHz | Rel-14 - 10/20MHz Rel-15 - 10/20/Nx20MHz |
| Resource multiplexing across vehicles | Time division multiplexing TDM only | TDM and Frequency-division multiple (FDM) access |
| Hybrid automatic repeat request (HARQ) Retransmission | no | ✓ |
| Waveform | Orthogonal Frequency Division Multiplexing (OFDM) | Single Carrier Frequency Division Multiplexing (SCFDM) |
| Modulation support | Up to 64QAM | Up to 64QAM |

Fig 4: DSRC and C-V2X comparison

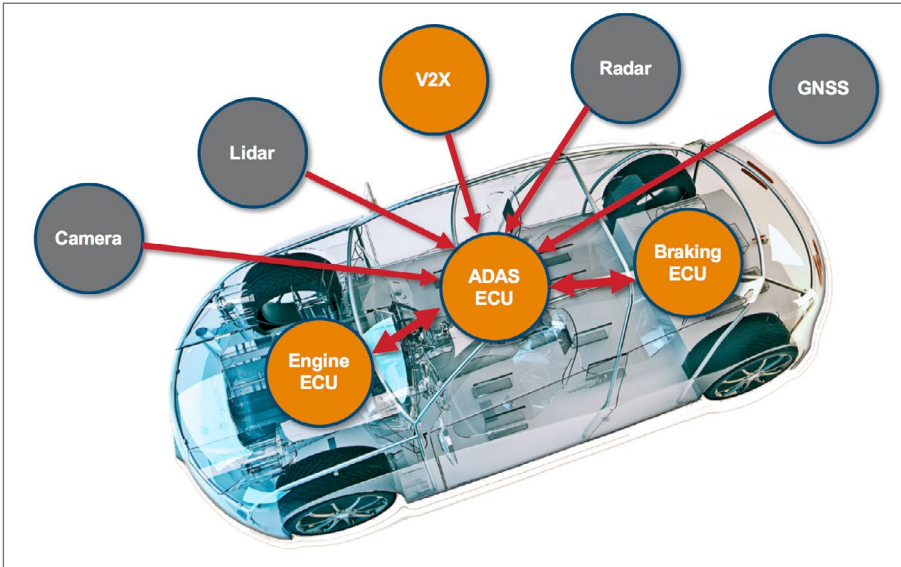

Fig 5: V2X as a sensor in an ADAS system

In another possible operation mode of this approach, the Day-1 applications are outsourced from the V2X control unit to a host system. In this case, the V2X control unit acts as the communication module, with the V2X control unit supporting only part of the V2X stack including facility layer, network and transport layer, plus security processing.

All generated V2X messages are transferred via Ethernet to the host system. In the host system, the appropriate facility layer proxy receives the data. Positioning data is either collected from the control unit's internal positioning solution or provided

by the host system via an external interface, complete with the vehicle status data.

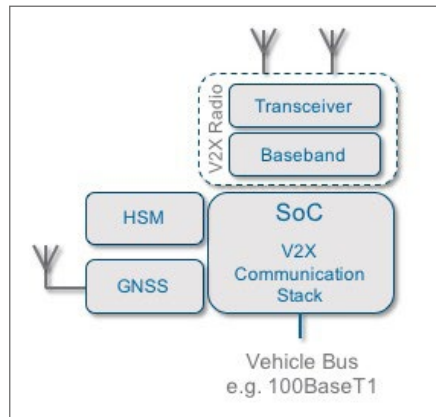

Fig. 6: Architecture of an independent control unit

Figure 7 presents a comparison of the two approaches for an independent V2X control unit.

3.2. Distributed V2X system

A second possible approach is a distributed system. The idea here is to position the transmitter/receiver unit, also called V2X radio, in close proximity to the antenna, with the actual V2X application being operated on a physically remote computing unit, called TCU SoC in figure 8.

Figure 9 illustrates the distribution of software blocks in a distributed approach. Only the radio access layer is operated directly at the antenna on a V2X radio chip set, with the data being translated into digital IP data streams (IP data) directly at the antenna and then transferred to a computing unit. This is also called a RF2IP approach.

This distributed implementation approach will also support even more complex vehicle architectures with various domains and domain controllers (domain centralized), as well as vehicle architectures with central high-performance computers (vehicle centralized). In these architectures, sensors will be kept as simple as possible, with the intelligence being shifted to so-called zonal gateways. For processing, the data will

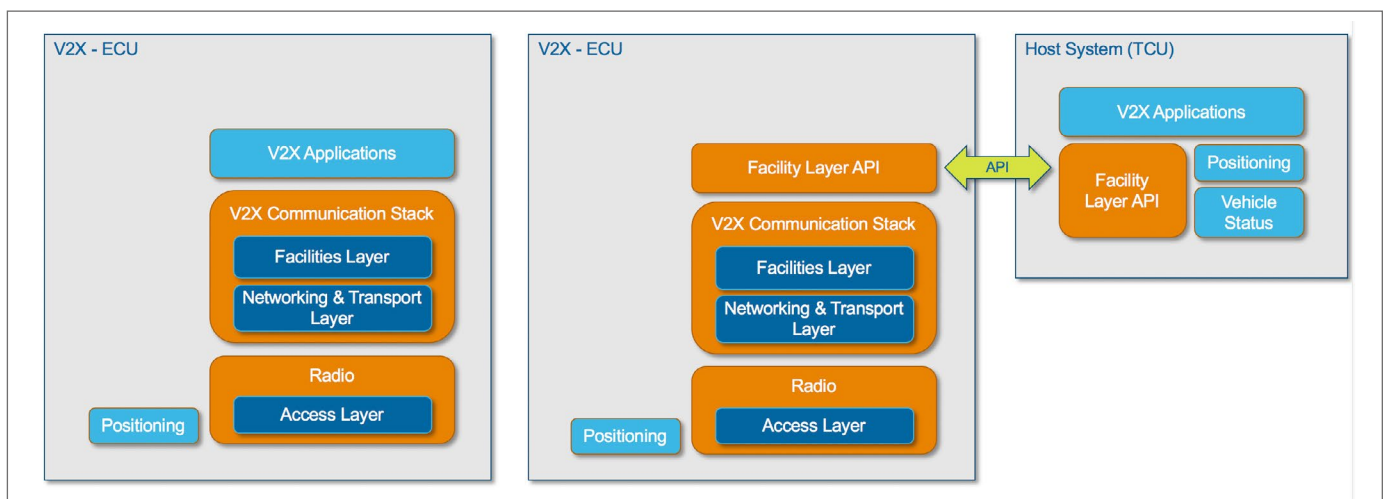

Fig. 7: Software blocks for V2X Application in ECU (left); outsourced V2X application (right).

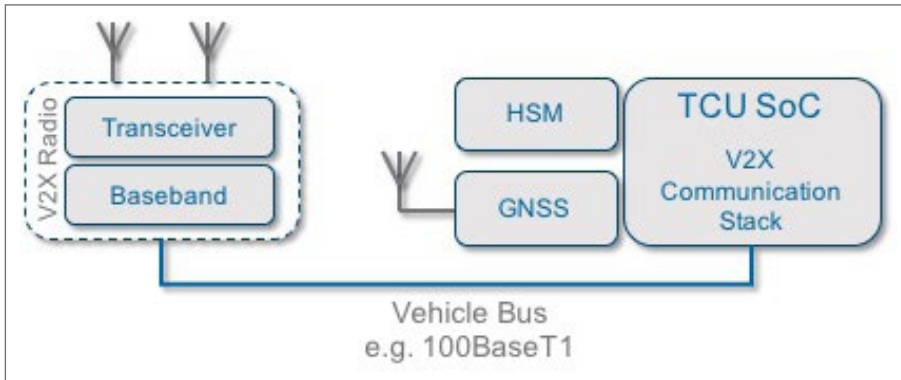

Fig. 8: Distributed V2X system

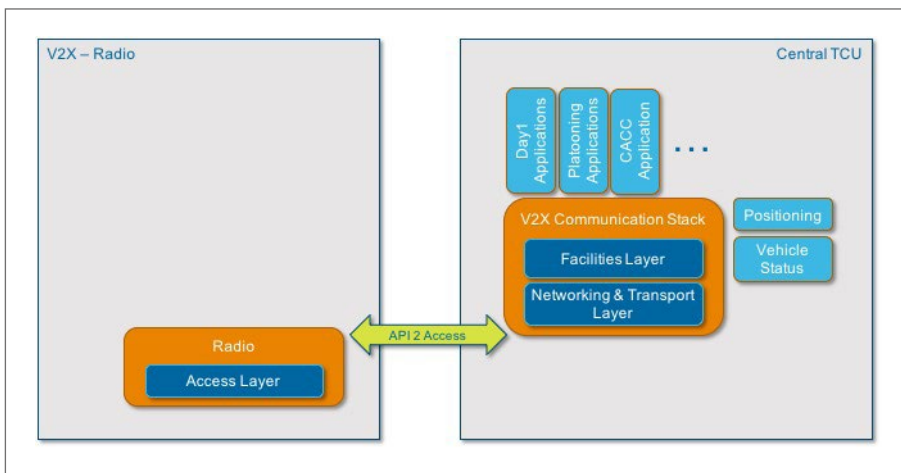

Fig. 9: Distribution of software blocks in a distributed approach

be transferred from the gateways to central high-performance computers, on which the actual applications will be run.

3.3. V2X antenna architecture

Another major challenge in vehicle architecture is the selection of suitable mounting sites for the V2X antennas. Figure 11 illustrates typical mounting areas on a passenger car. One possible location is a central position in the shark fin antenna, often combined with an antenna integrated in the mirror base, or a combination of antennas in the vehicle's wing mirrors.

Even though basically the system can be operated with just one antenna, usually two V2X antennas are mounted on the vehicle at the same time. Often at least one of them is equipped with a compensator for balancing power loss as described in Chapter 4.4.

The use of two antennas ensures best possible all-round visibility (360° in the horizontal plane) and the required high transmission and reception performance. Unlike other radio communication services, V2X is designed to increase traffic safe-

ty. To achieve this, the systems must be able to receive and send information from and into all directions. Even though the most important directions are front and back, the vehicle's sides must also feature sufficient radio coverage at all times. Blind spots are not acceptable.

Defined minimum signal strength in all directions is another important prerequisite for a cooperative communication system designed to increase traffic safety.

The 5.9 GHz frequency band used in V2X communication causes comparatively high free space loss, reducing the system's range. In addition, the wavelength of approx. 5 cm in the context of the high frequency will generate considerable shading and interference, resulting in significant signal loss and reduced range.

While an antenna mounted on a steel roof will still deliver a very good performance, a glass roof may cause significant changes in the directional characteristics. Roof railing and crowning may also have a major impact on system performance.

Figure 12 shows different antenna diagrams and the expected minimum antenna gain (in yellow) in the various

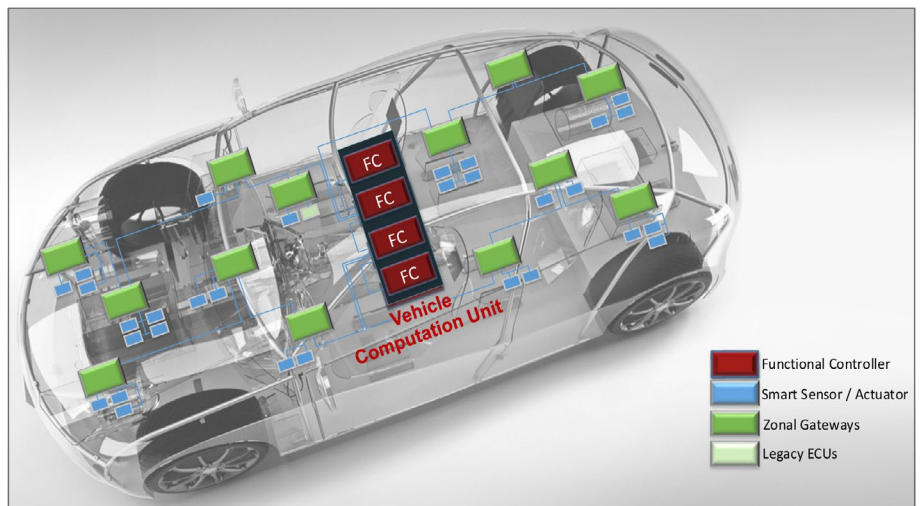

Fig. 10: Future vehicle architecture with high performance computers and zonal gateways

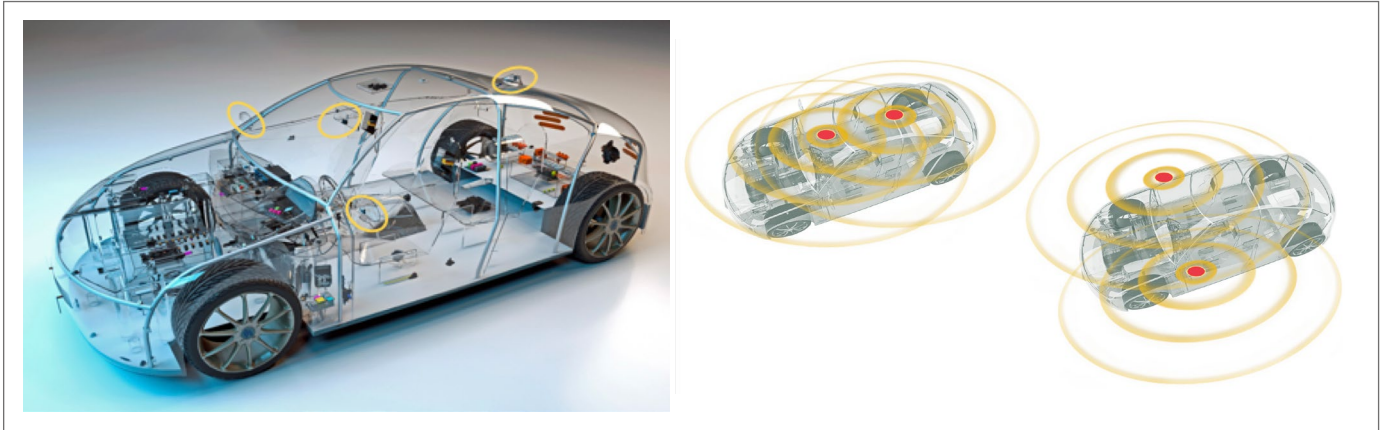

Fig. 11: Typical V2X antenna mounting areas in a car

directions surrounding the vehicle. For these reasons most vehicle types will require multi antenna systems. Additional system margins must be reserved for temporary modules like roof racks or trailers.

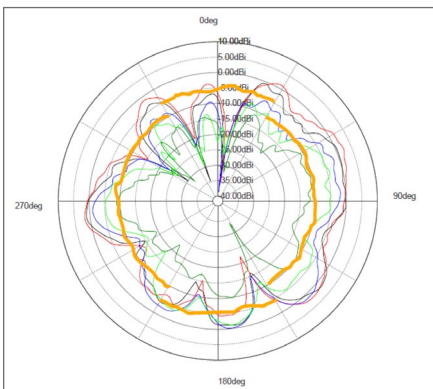

Fig. 12: Different radiation diagrams of 5.9 GHz antennas and the expected minimum antenna gain (in yellow)

4. TE product overview V2X

4.1. Antennas for cars

As shown in figure 11, typical mounting areas for two antennas (antenna diversity) are either on the vehicle’s left and right or at the front and rear. Often directional antennas are used to ensure optimum antenna decoupling. This is especially important for antenna positions at the left and right side of the vehicle. But front antennas, too, are mostly directional, thus requiring special compensation.

This compensation refers to the influence of the windscreen, as this antenna often is mounted behind the windscreen (see figure 13 (a) antenna mounted in mirror base).

As the windscreen itself is mounted at a strongly tilted angle and as the frequencies used are very high, lensing effects may occur, which the antenna then must compensate (see figure 13 (b) Antenna diagram subject to windscreen influence). The rear antenna usually is just a “simple” antenna, without special compensation or directivity, mounted as part of either the shark fin antenna system or an integrated antenna system.

The integration of a 5.9 GHz antenna in such an antenna system, together with the roof curvature and, for example, a glass roof, usually cause preferred emittance towards the vehicle’s rear, which ensures good decoupling of rear and front antenna.

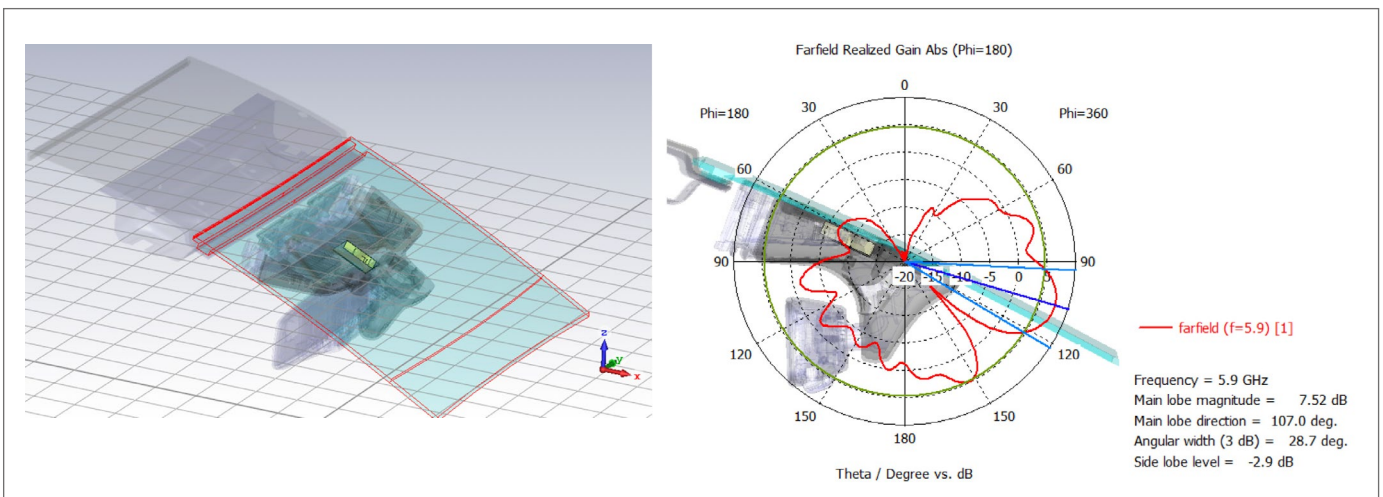

Fig. 13: (a) Antennas mounted in inner mirror base; (b) Directional diagram of a V2X antenna subject to windscreen influence

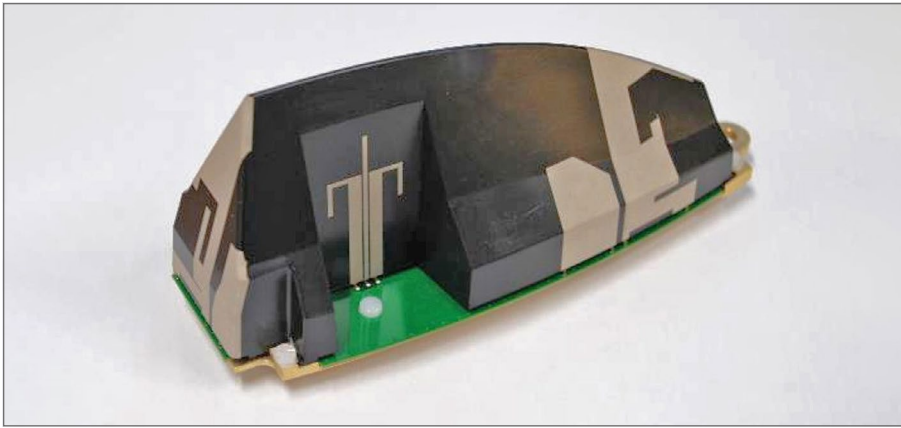

Fig. 14: V2X antenna concept with fully integrated antenna system for the shark fin.

Figure 14 shows a TE V2X antenna concept for minimizing the roof construction's influence on antenna performance.

In this concept the antenna is lifted off the ground plane to the maximum height of the antenna housing by means of a microstrip line and a balun. This minimizes the impact of roof curvatures or a glass roof.

4.2. Antennas for trucks

All factors mentioned with regard to the directional characteristic requirements of V2X antennas ap-

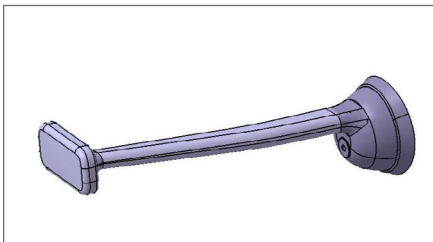

Fig. 15: V2X antenna concept with winglet design for heavy-duty vehicles

ply not only to passenger cars but also to trucks. However, due to their length, all-round visibility is much harder to achieve in trucks.

Therefore, winglet antennas as shown in figure 15 are mounted to the left and right of the front end of the driver cabin. Figure 15 shows a new heavy-duty vehicle concept developed by TE Automotive Wireless for different cabin constructions and trailer versions. Externalizing the actual antenna into a so-called winglet with a flexible base generates good emittance from the vehicle, while a spring element integrated in the base point prevents antenna shear.

Figure 16 illustrates directivity of a "winglet antenna" into the left half-space with resulting antenna gain from 2.1 dBi to 3.5 dBi.

Figure 17 shows signal propagation as influenced by the form of a truck.

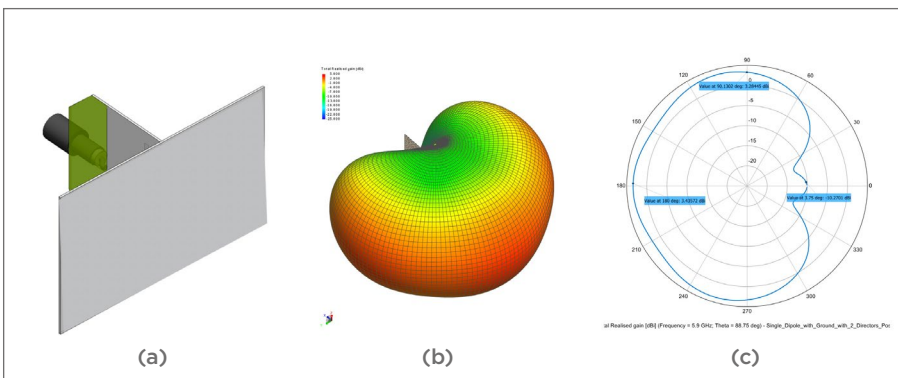

Fig. 16: Winglet antenna: (a) Antenna, (b) 3D antenna diagram, (c) 2D antenna diagram

The reflections of the electromagnetic waves on the vehicle cause an interference pattern. The winglet design of the antennas assures good coverage for also for the rear part of the trailer.

4.3. Antennas for two-wheelers

Quite a different antenna challenge must be solved in motorcycles. While a car will remain more or less level on the road, a motorcycle will strongly shift around its longitudinal axis in any curve. This poses problems, as the V2X communication specifications define vertical antenna polarization. Every time the motorcycle navigates a curve, the position of the antenna shifts, turning a vertical antenna into a mixture of vertical and horizontal antenna. To minimize this effect, TE Wireless, in cooperation with the Connected Motorcycle Consortium (CMC), has developed special antennas (figure 18).

Related tests and studies have shown that motorcycle accessories, too, will impact antenna characteristics. Therefore, the use of double antenna systems is also recommended in V2X motorcycle technology applications.

4.4. Compensator

Depending on the mounting scenarios in the vehicle, coaxial cables often must cover long distances between antenna and V2X control unit. A conventional coaxial cable typically features approx. 0.12 dB attenuation per 10 cm at 5.9 GHz and approx. 0.4 dB attenuation per connector. In a 2 m cable this can result in up to 3 dB attenuation. Temperature effects and ageing may cause additional signal attenuation.

Use of a compensator can balance these effects. Antenna recognition and additional important information, i.e. temperature and transmission power, is transferred to the V2X control unit via diagnostic interface.

The structure of a V2X antenna vehicle architecture with compensator is shown in *figure 19*.

4.5. V2X control units with vehicle network connection

For fully integrated V2X communication customer solutions TE has developed a V2X control unit in platform design. The platform interacts seamlessly with the TE antenna and compensator portfolio.

The V2X platform in *figure 20* features a multicore system-on-chip (SoC) for the V2X stack, an application programming interface (API), a V2X one-chip solution (transceiver and baseband), and a hardware security module (HSM) for secure V2X communication. The system uses a voltage supply of up to 24 V. Communication with other vehicle control units is performed via automotive Ethernet (100Base-T1), classic high speed CAN or CAN FD.

Due to the V2X control unit's high processing power requirements, a multicore architecture (ARM cortex) SoC with integrated automotive core (Cortex M3) was selected.

The application cores (Dual Cortex A7) are used for the software-based host services (V2X stack, API, etc.) to enable V2X functions and automotive Ethernet communication, whilst the automotive core is used for secure communication with the other ECUs in the CAN vehicle network.

The application cores can verify up to 1.000 incoming V2X messages per second and transfer 10 signed messages in the same timeframe. Application data is transferred via automotive Ethernet (100Base-T1) to other control units for further processing and visualization. In addition, the application cores also manage the firmware (FW) upload process for the V2X one-chip. The

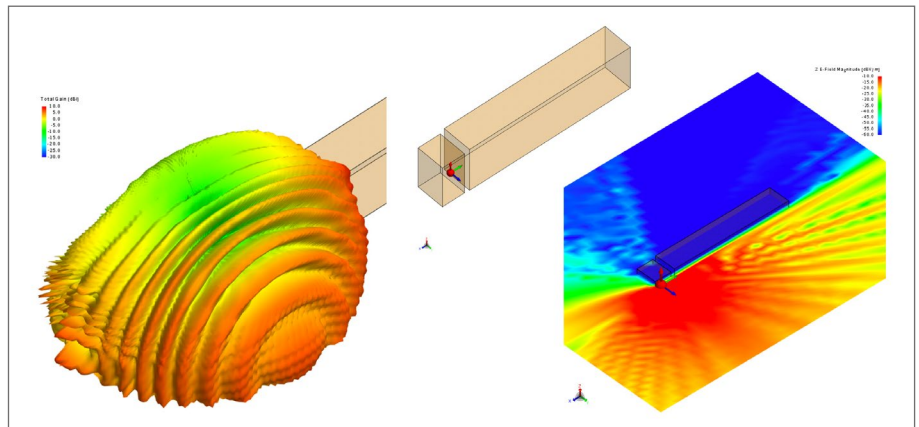

Fig. 17: Winglet simulation on a truck; (a) 3D far field; (b) truck model; (c) electrical near field at the truck

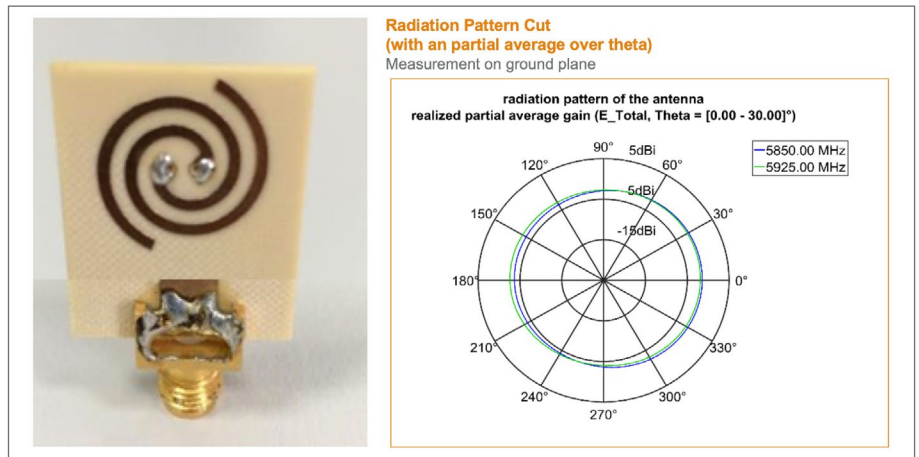

Fig. 18: (a) left: Antenna concept for V2X antennas on motorcycles; (b) right: Radiation pattern of the antenna

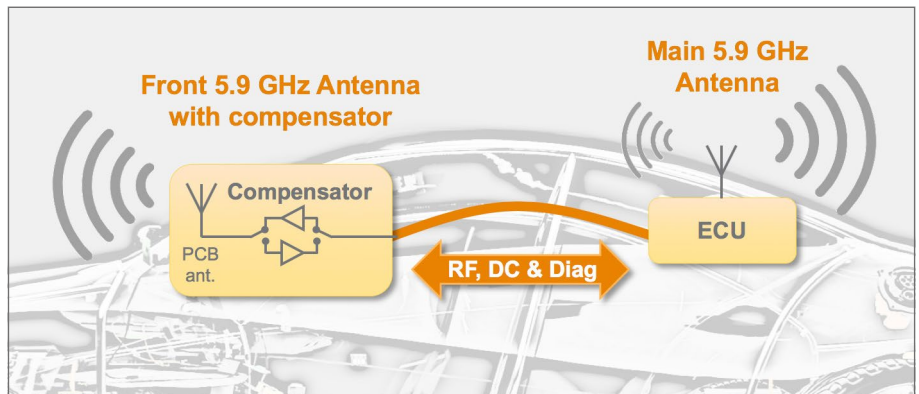

Fig. 19: V2X compensator to bridge long distance between antenna and ECU

FW is stored in a separate external flash.

The V2X control unit's software consists of several component (see *figure 21*), the most essential being the two operating systems (OS) used: QNX and Autosar.

QNX is the operating system of the application cores hosting the V2X stack and those V2X applications that support both standards, ETSI ITS G5 and 802.11p (WAVE) for the European and the U.S. markets. SomelP is used as communication protocol for the automotive Ethernet (100BaseT1) interface.

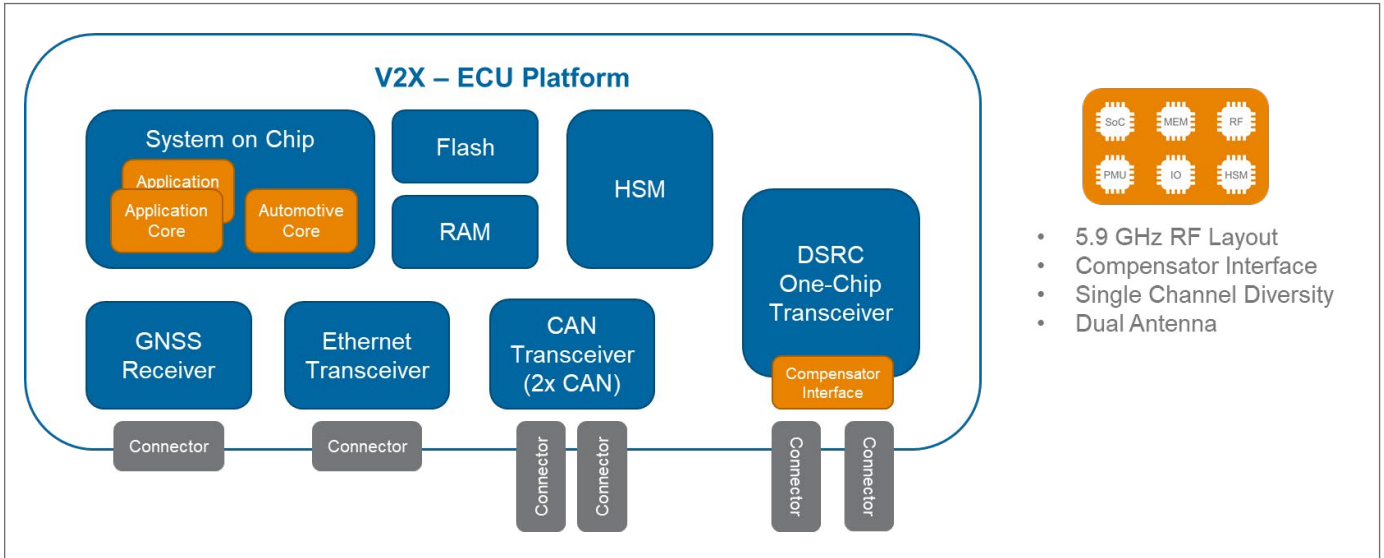

Fig. 20: Hardware Block Diagram of V2X ECU

AUTOSAR is the operating system of the automotive core, which is responsible for functions like unified diagnostic services (UDS) and wired vehicle communication.

Additional components are responsible for handling the V2X one chip’s firmware, the HSM, and the global navigation satellite system (GNSS). The software architecture integrates all above components for seamless cooperation, easy updates, and comfortable replacements and upgrades. The platform meets all security requirements of a control unit in automotive telematics environments, including secureboot, encryption, and signature.

Inter-processor communication (IPC) manages the communication of application cores and automotive core. With AUTOSAR and QNX, functional safety engineered versions can be derived from the V2X platform. This approach also enables implementation of the architectures described in chapter 3 “Vehicle architectures and V2X”

TE’s latest V2X control unit designs support both DSRC and C-V2X technologies. As a member of the C2C Communication Consortium and 5GAA (5G Automotive Association) TE is always up to date with latest standard developments.

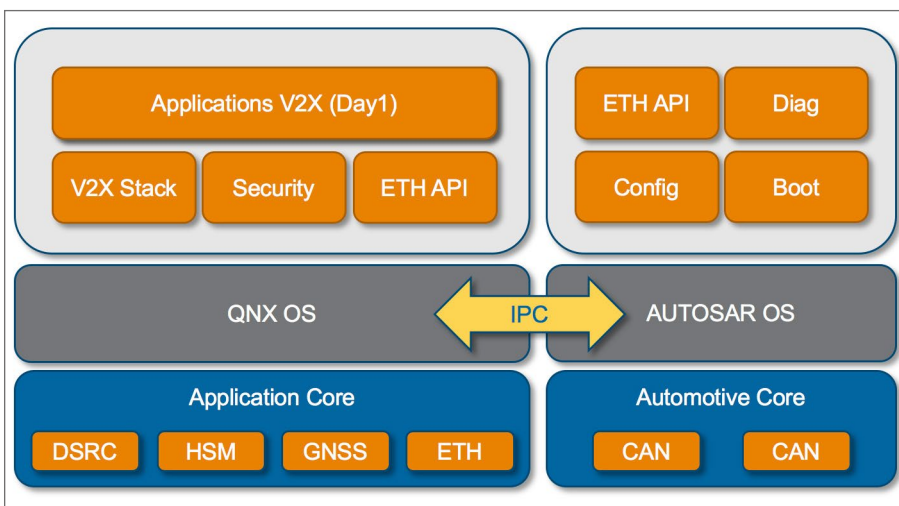

Fig. 21: Software Block Diagram of V2X ECU

5. Summary

As discussed in the previous chapters, there are many approaches to implement a V2X system in a vehicle. The most important decision remains, which standard to use.

Furthermore the current vehicle architecture has to be considered to find an optimal solution for the V2X system. Antennas, compensators, cables, connectors and electronics have to fit seamlessly in the vehicle architecture.

TE Automotive offers end-to-end solutions (see *figure 22*) for all types of vehicles, from antennas to compensators and HF connectors, to complete V2X control units and vehicle network connectors.

TE's proprietary single source system solutions are developed to meet individual customer requirements, validated and qualified (see *figure 22*). Required certification processes will be implemented in cooperation with the customer.

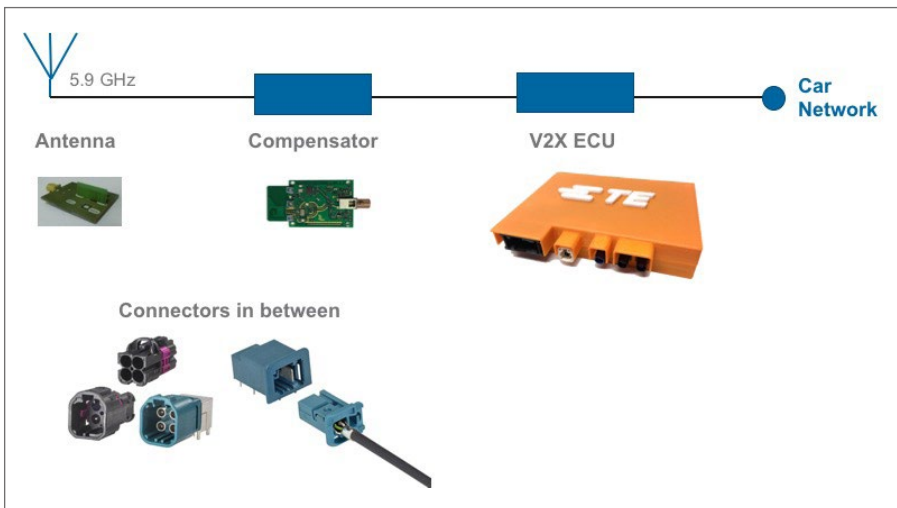

Fig. 22: Complete V2X System

References

Figure 1, 12: © Car2Car Communication Consortium

Figure 3: @ TE / @ Car2Car Communication Consortium

Figure 11: © TE / © Car2Car Communication Consortium

Figure 2, 4 - 10, 13 - 22: © TE Connectivity

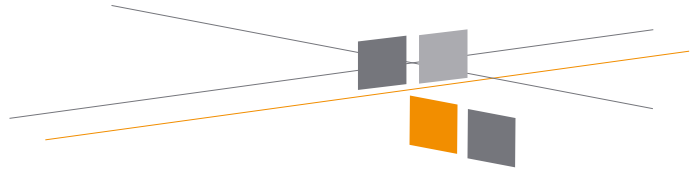

About TE Connectivity

TE Connectivity Ltd. (TE) is a \$14 billion global technology and manufacturing leader creating a safer, sustainable, productive, and connected future. For more than 75 years, our connectivity and sensor solutions, proven in the harshest environments, have enabled advancements in transportation, industrial applications, medical technology, energy, data communications, and the home.

With 80,000 employees, including more than 8,000 engineers, working alongside customers in approximately 140 countries, TE ensures that EVERY CONNECTION COUNTS.

Learn more at www.te.com and on [LinkedIn](#), [Facebook](#), [WeChat](#) and [Twitter](#).

TE Connectivity Germany GmbH

Ampèrestrasse 12-14
64625 Bensheim | Germany

www.TE.com

© 2019 TE Connectivity. All rights reserved.

EVERY CONNECTION COUNTS, TE, TE Connectivity, and TE connectivity (logo) are trademarks.
AUTOSAR, FAKRA, IEEE, and QNX are trademarks.

Other logos, product and company names mentioned herein may be trademarks of their respective owners.

DISCLAIMER This document reflects the state-of-the-art result of the work of TE Connectivity (TE). While TE has made every reasonable effort to ensure the accuracy of the information in this document, TE does not guarantee that it is error-free, nor does TE make any other representation, warranty or guarantee that the information is accurate, correct, reliable or current. TE expressly disclaims all implied warranties regarding the information contained herein, including, but not limited to, any implied warranties of merchantability or fitness for a particular purpose. The document is subject to change without notice. Consult TE for the latest dimensions and design specifications.